

2J6516B 2J6516BG 2J6516M 2J6516MG (DATASHEET)

Type	Combined antenna
Frequencies	TETRA (380 - 500 MHz) GPS (1575.42 MHz) WIFI / BLUETOOTH (2.4 GHz)
Mounting	B - Body Mount M – Magnetic Mount
Revision	00



P. Tipul

D. Noble



1. PRODUCT SELECTOR

2J6516B	-	GPS L1 filtered body mount version.
2J6516BG	-	GPS-GLONASS filtered body mount version.
2J6516M	-	GPS L1 filtered magnetic version.
2J6516MG	-	GPS-GLONASS filtered magnetic version.

2. SPECIFICATION

2.1. Electrical Specifications

Tetra (Cable 1)

Frequencies*	TETRA (380 - 500 MHz)
Bandwidth	15 MHz +/- 5 MHz
Impedance	50 Ohms
Polarization	Horizontal
Gain	6dBi
VSWR	<2:1
Power handling	50W

* Center frequency can be tuned between 380-500 MHz

Navigation (Cable 2)

	2J6516B 2J6516M	2J6516BG 2J6516MG
Frequencies	GPS (1575.42 MHz)	GPS (1575.42 MHz) GLONASS (1592 - 1610 MHz)
Impedance	50 Ohms	
Noise figure	1.15dB	
Polarization	RHCP	
LNA Gain*	26dB at 3V, 27dB at 5V	
VSWR	<1.2:1	
Voltage supply	2.7V - 5.5V	
Current	15mA - 25mA	
Power (max.)	138mW	
Note	Filtered antenna	

* Values are just for LNA without filter. With filter, output gain is 23dB at 3V and 24dB at 5V

Wifi (Cable 3)

Frequencies	TETRA (380 - 500 MHz) GPS (1575.42 MHz) WIFI / BLUETOOTH (2.4 GHz)
Impedance	50 Ohms
Noise figure	1.15dB
Polarization	Vertical
Gain	2dBi
VSWR	<2:1

General

Operating temperature	-40°C to +85°C
Certificates	IP67, IK09

2.2. Connection Specifications

Cable 1 (Tetra):
Connector type: FME male
Cable: RG58
Cable length: 15 cm

Cable 2 (Navigation):
Connector type: SMA male
Cable: RG174U
Cable length: 15 cm

Cable 3 (Wifi):
Connector type: SMA male
Cable: RG174U
Cable length: 15 cm

For different cable length and connector type ask our sales team.

2.3. Mechanical Specifications and Dimensions

2.3.1. Body mount (2J6516B/2J6516BG)

Material: Lid: ABS / Base: Zamak / Gasket: TPE
Max. dimensions: 142.6mm x 49.5mm
Weight: 480 g 'weight counted with connection above'
Colour: Black/ Green/ White (for different colours please ask our sales team)

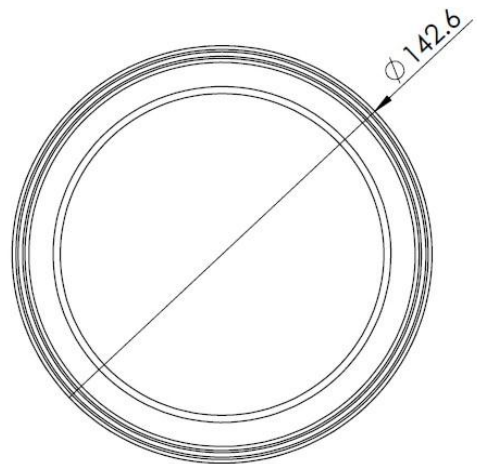
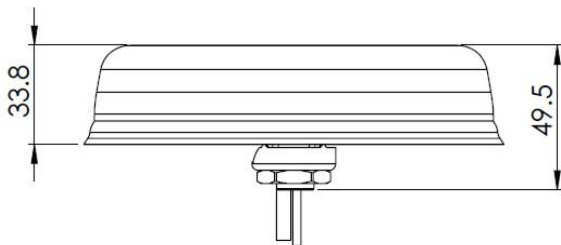

2.3.2. Magnetic mount (2J6507M/2J6507MG)

Material: Lid: ABS / Base: Zamak
 Max. dimensions: 137.4 mm x 30 mm
 Colour: Black/ Green/ White (for different colours please ask our sales team)

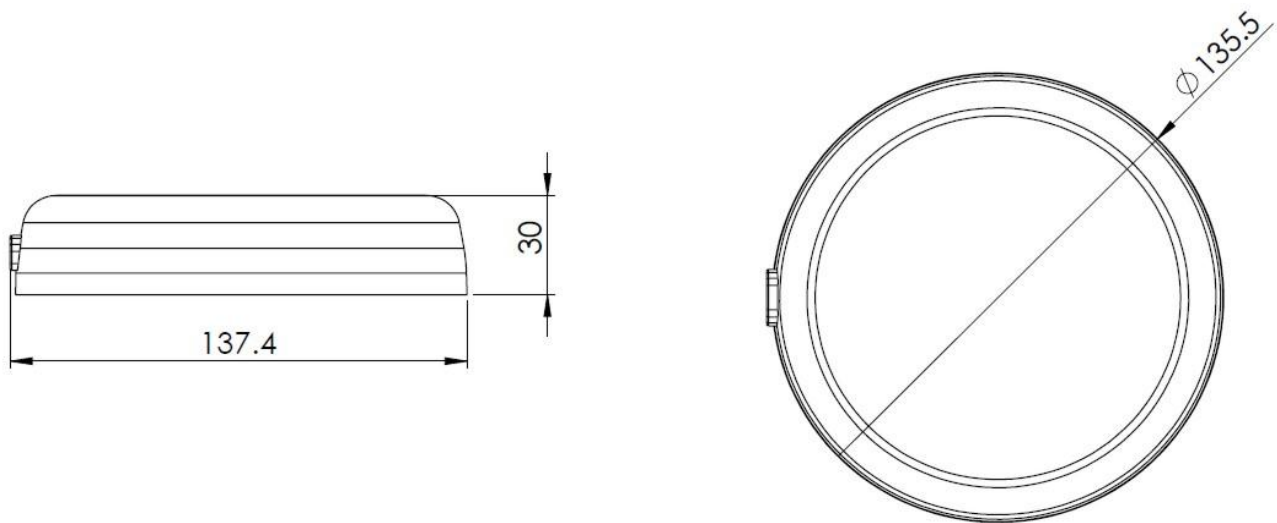

3. MEASUREMENT

3.1. 3D spherical

GNSS

1575MHz
 Freq = 1.5754GHz Az= 45 EL= 45

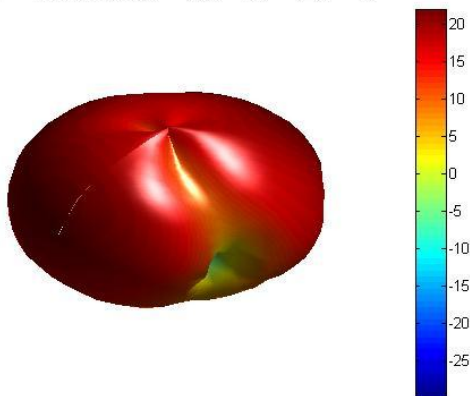

Measured at 20x20cm groundplane and with 3V power supply.

1605MHz
 Freq = 1.6054GHz Az= 45 EL= 45

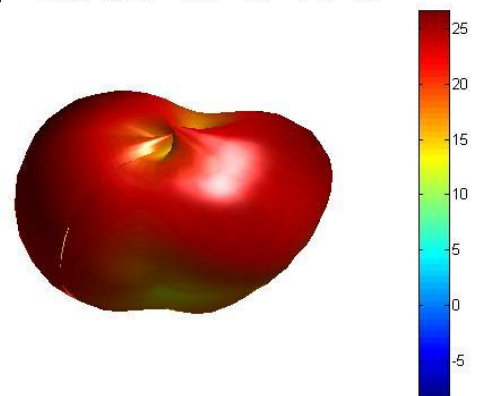

Measured at 20x20cm groundplane and with 3V power supply.

WiFi
2.4GHz
Freq = 2.4GHz Az= 45 EL= 45

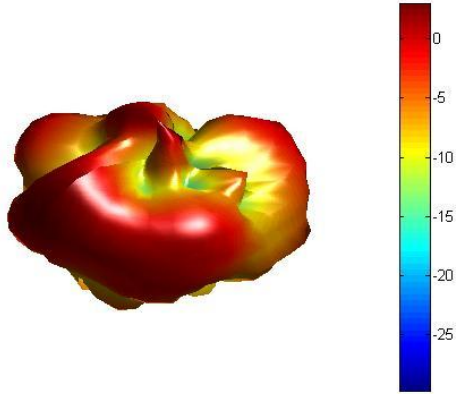

Tetra
430MHz
Freq = 0.4300GHz Az= 45 EL= 45

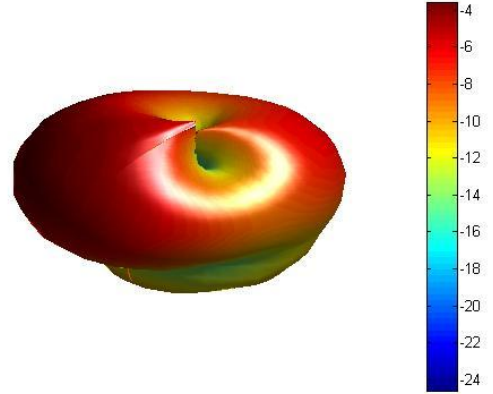

3.2. S11

Log Mag (WiFi)

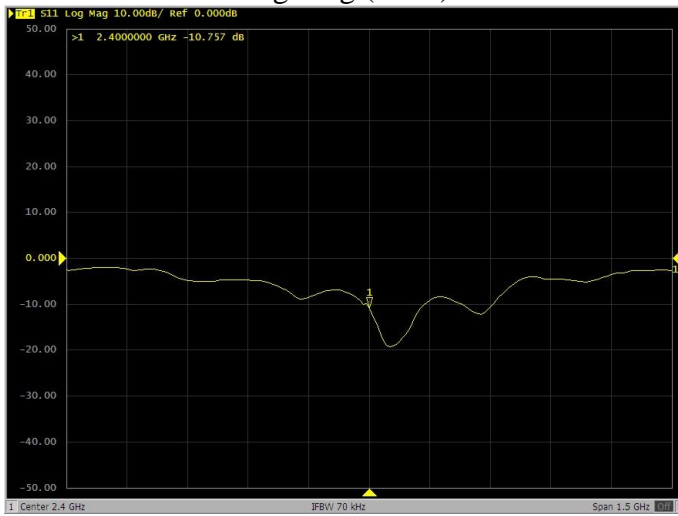

VSWR (WiFi)

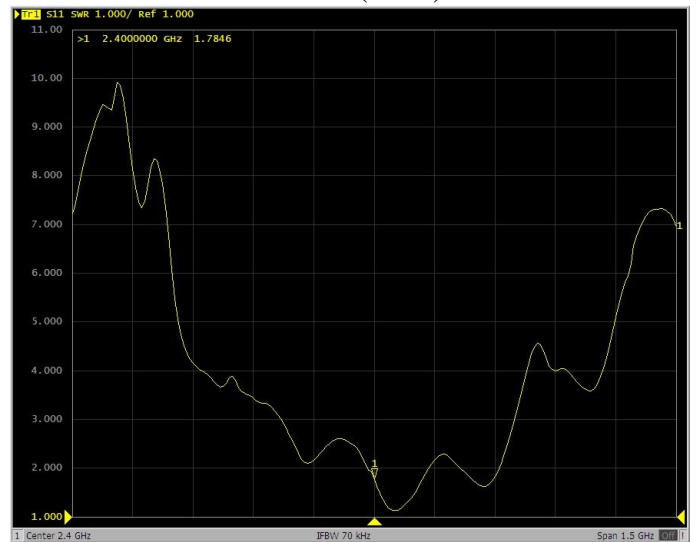

Log Mag (Tetra)

VSWR (Tetra)

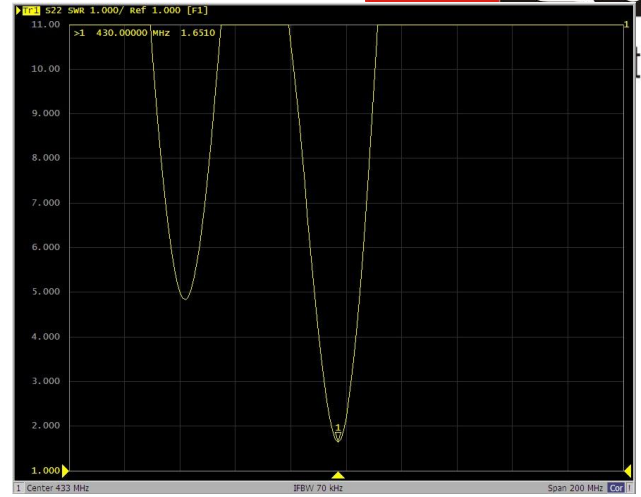
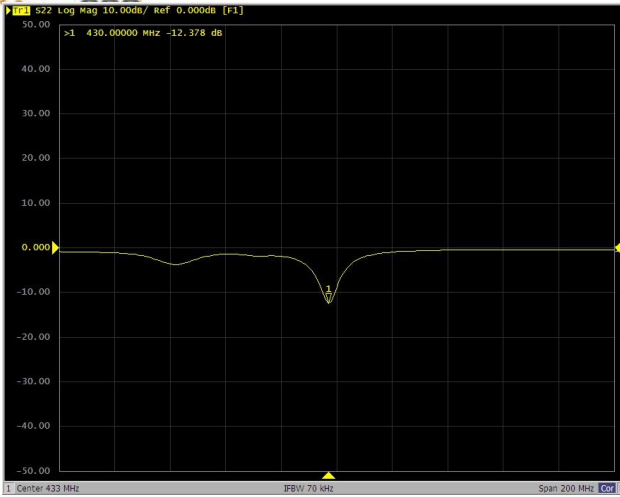

3.3. S21

GNSS gain at 3V

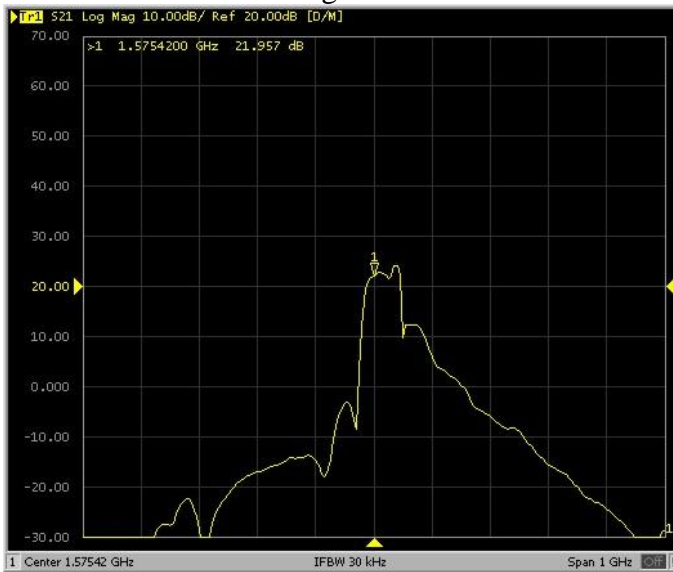

Tested with 1m cable length.

GNSS gain at 5V

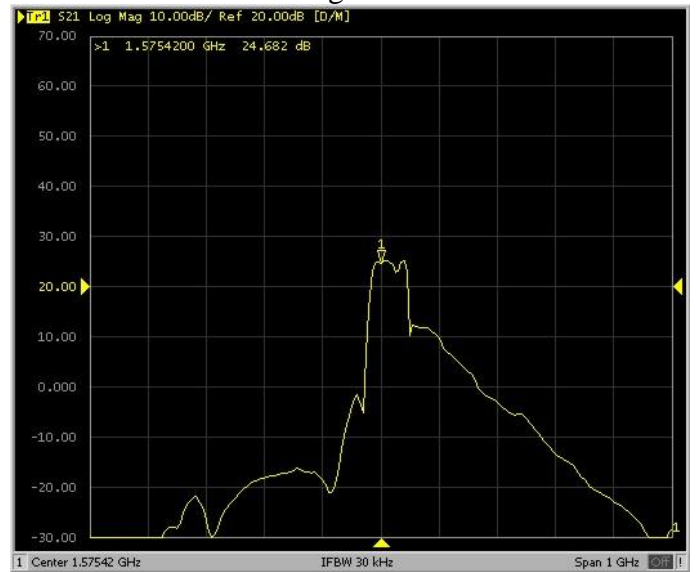

Tested with 1m cable length.

4. IMAGES

