

2J6A42B (DATASHEET)

Type	GSM-Railway antenna/ISM antenna
Frequencies	GSM-R (876 - 924 MHz) ISM (868/915 MHz)
Mounting	Body Mount
Revision	00



P. Tipul

D. Noble

1. SPECIFICATION

1.1. Electrical Specifications

Mobile (Cable 1)

Frequencies	GSMR (871-960 MHz) / ISM (868-928 MHz)
Impedance	50 Ohms
Polarization	Vertical
Gain	4 dBi
VSWR	<2:1
Power handling	50W

1.2. General Specifications

Certificates	IK67, IK09, IP69K
Operating temperature	-40°C to +85°C

1.3. Connection Specifications

Connector type:	SMA
Cable:	RG174U
Cable length:	30 cm

For different cable length and connector type ask our sales team.

1.4. Mechanical Specifications and Dimensions

Material:	Base: Zamak / Gasket: TPE / Lid: ASA
Max. dimensions:	77.3mm x 66.5mm (after mounting)
Weight:	143 g 'weight counted with cable above'
Colour:	Black (for different colours please ask our sales team)

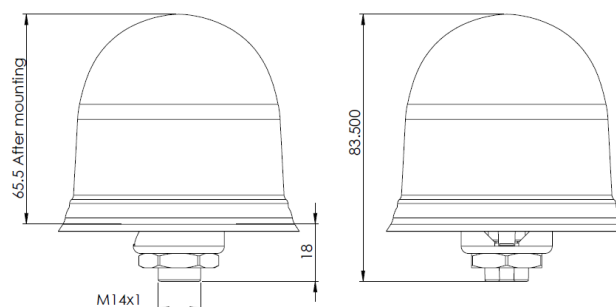
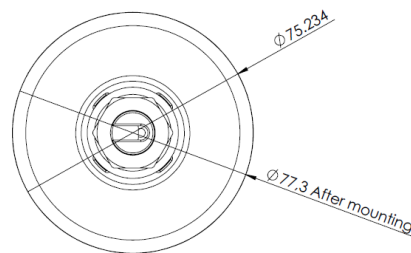

2. MEASUREMENT

- Measured on 45 cm x 45 cm ground plane

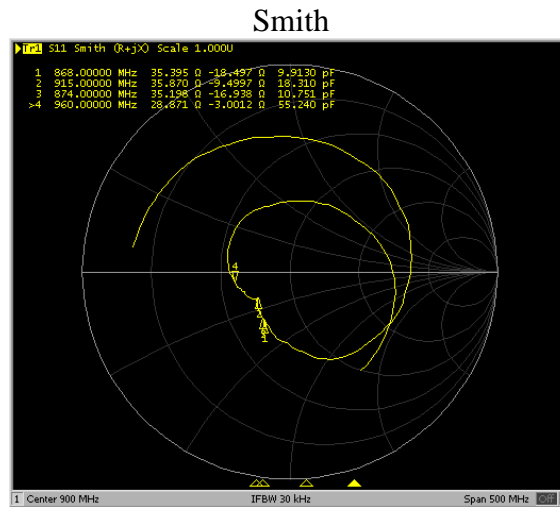
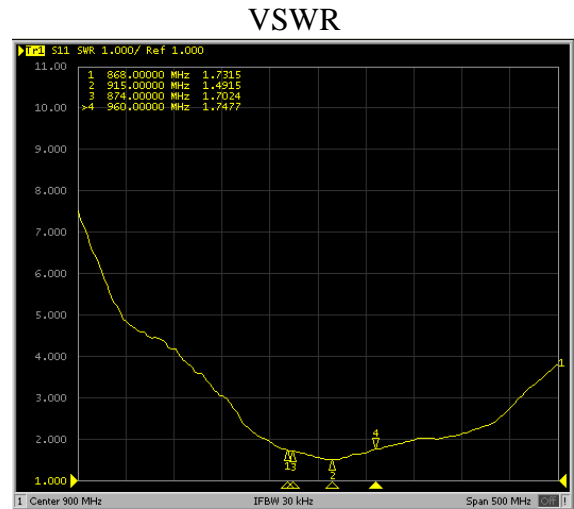
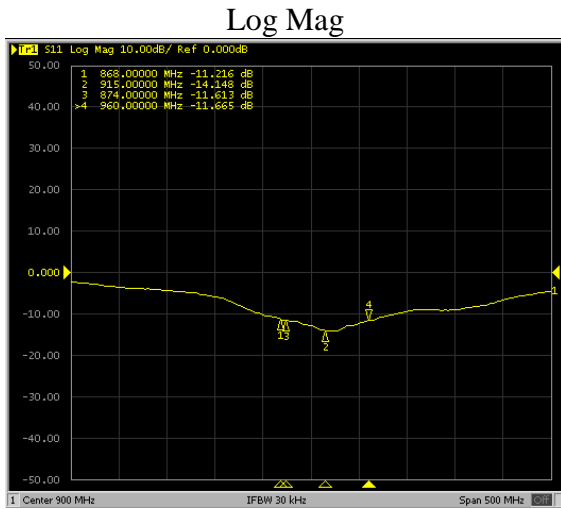

Freq = 0.908GHz Az= 45 EL= 45

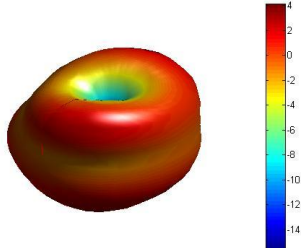

Freq = 0.875GHz Az= 45 EL= 45

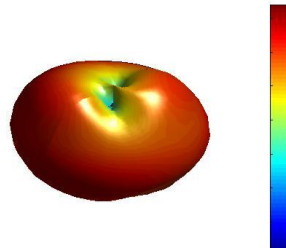

Freq = 0.919GHz Az= 45 EL= 45

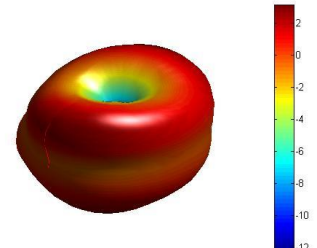

3. IMAGES

