

DATASHEET

Type	GNSS antenna
Frequencies	GPS (1575.42 MHz)
Mounting	Any Surface Magnetic Mount Patch Mount
Part No.	2J4501MP
Revision	00



Contents

1. SPECIFICATION.....	2
1.1. Electrical Specifications	2
1.2. Connection Specifications	2
1.3. Mechanical Specifications and Dimensions	2
1.3.1. Mounting Type	2
1.3.2. Magnetic mount	3
1.3.3. Patch mount	3
2. MEASUREMENT.....	4
3. IMAGES.....	5

1. SPECIFICATION

1.1. Electrical Specifications

Frequencies	GPS (1575.42 MHz)
Impedance	50 Ohms
Polarization	RHCP
LNA Gain	32 dB typ. (5V)
Voltage supply	1.8V to 5V
Current	5mA (1.8V), 13mA (3.3V), 25mA (5V)
Power (max.)	125mW
Operating temperature	-40°C to +85°C

1.2. Connection Specifications

Suitable cables:	RG174
Cable length:	min. 15 cm
Suitable connectors:	All connectors suitable for cables above

1.3. Mechanical Specifications and Dimensions

1.3.1. Mounting Type

- Any Surface
- Magnetic Mount
- Patch Mount

1.3.2. Magnetic mount

Material: ABS
Max. dimensions: 12.7mm x 43mm x 40mm
Weight: 68 g 'weight with 3m cable length'
Colour: Black (for different colours please ask our sales team)

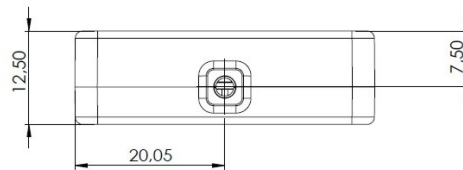
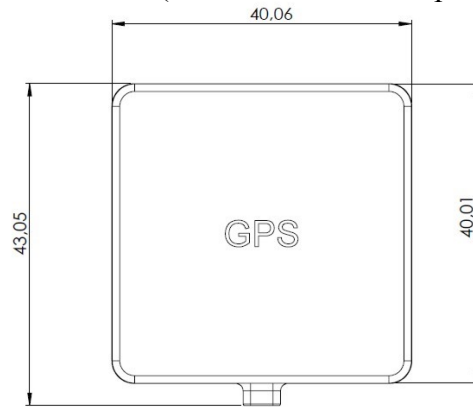

1.3.3. Patch mount

Material: ABS
Max. dimensions: 13.7mm x 43mm x 40mm
Weight: 68 g 'weight with 3m cable length'
Colour: Black (for different colours please ask our sales team)

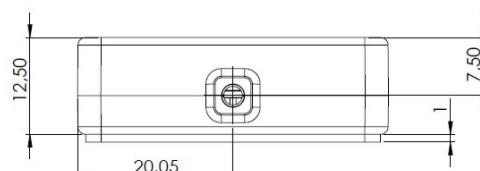
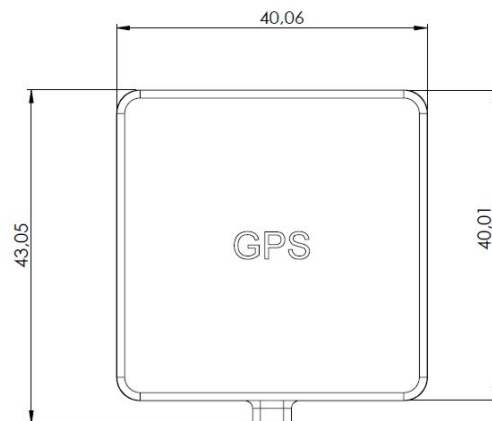

2. MEASUREMENT

Log Mag at 3V

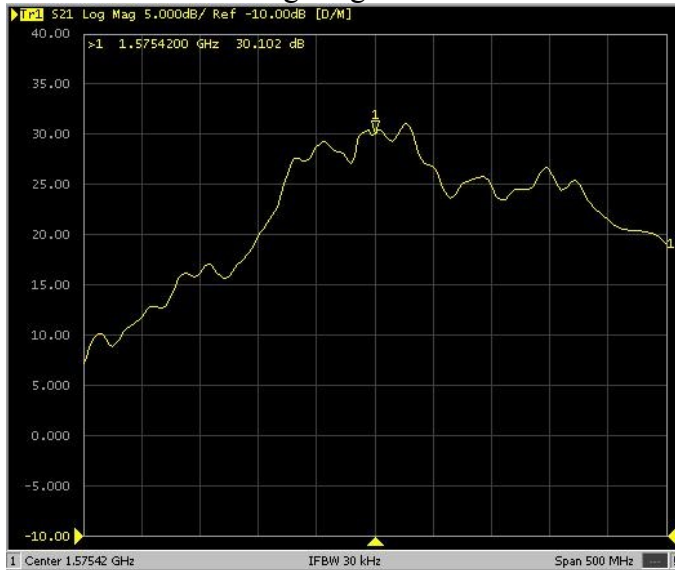

Tested with 3m cable length

Log Mag at 3V

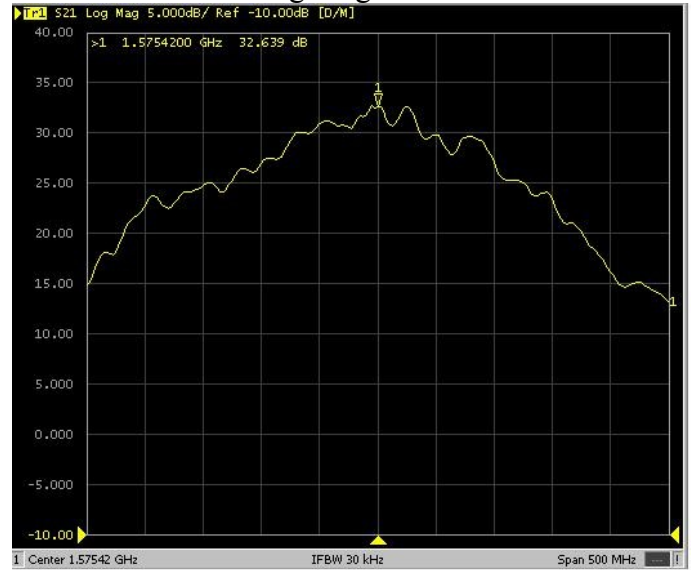

Tested with 5m cable length

Log Mag at 5V

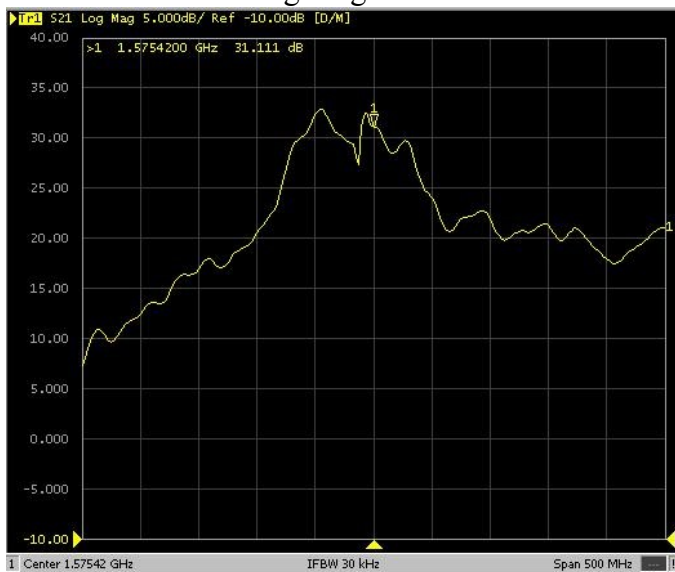

Tested with 3m cable length

Log Mag at 5V

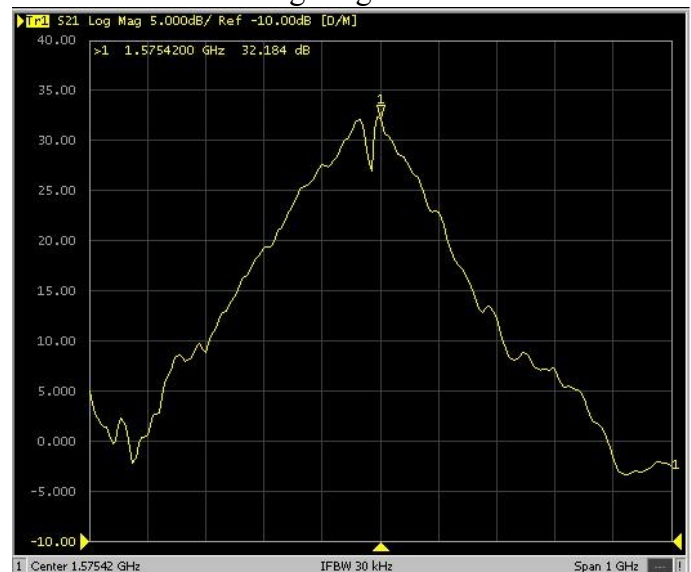

Tested with 5m cable length

3. IMAGES

